



Steel and Cement junkies:
we're hooked, what can we
do?

Julian Allwood
18th March 2014

















Ark Hotel:

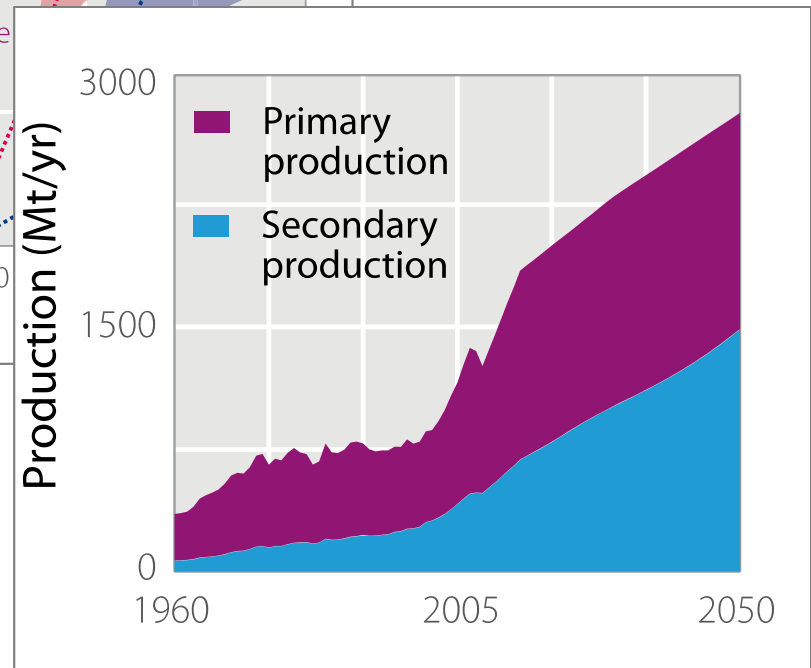
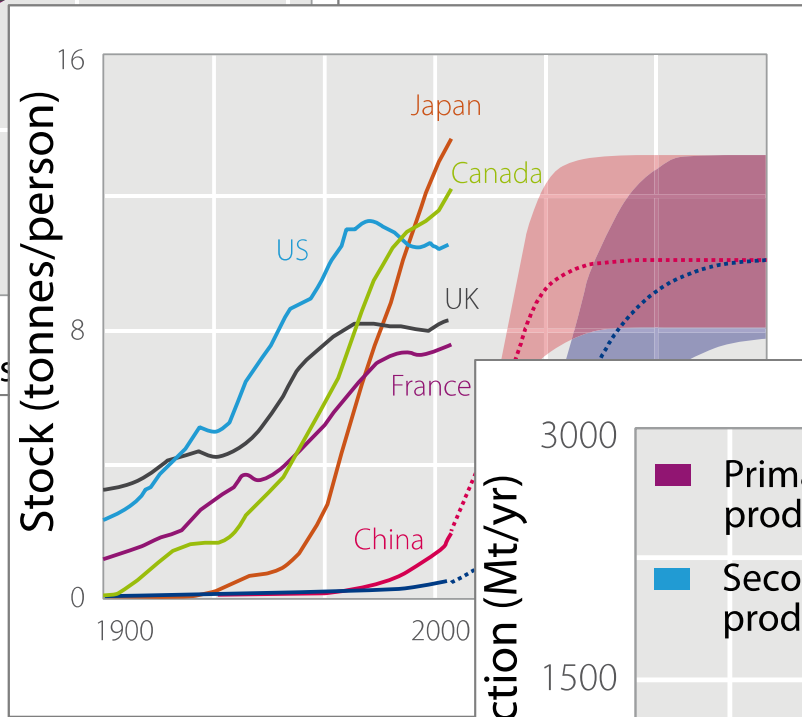
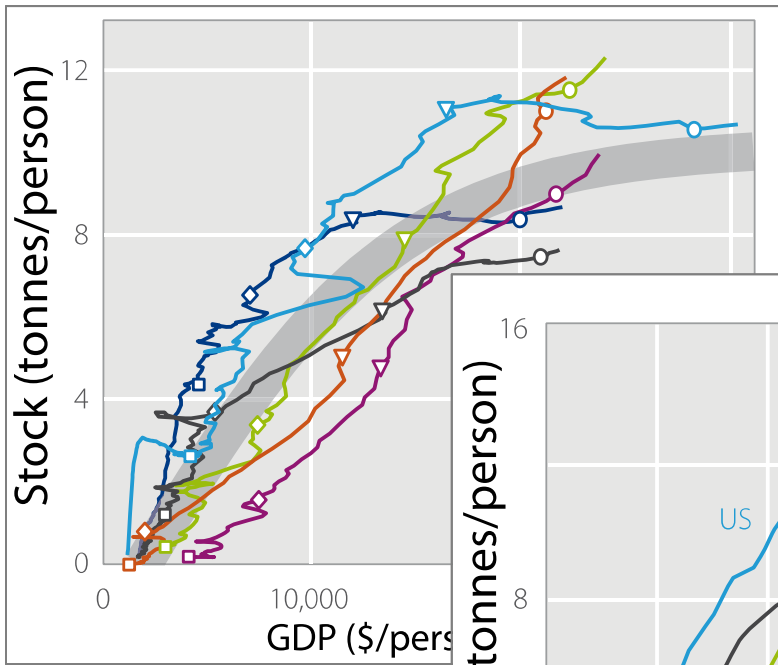

New Steel (2008)

1,040 Mt

Buildings
433 Mt
42%

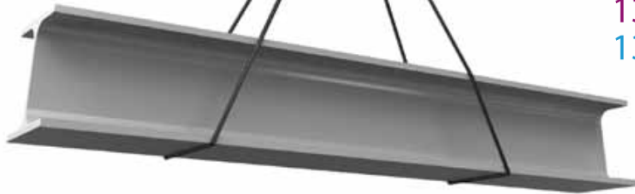

Infrastructure
150 Mt
14%

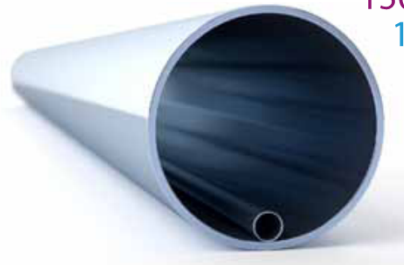

Metal goods
134 Mt
12%



Mechanical equipment
137 Mt
13%



Cars and light trucks
93 Mt
9%



Trucks and ships
28 Mt
3%



Domestic appliances
29 Mt
3%



Electrical equipment
27 Mt
3%



Consumer packaging
9 Mt
1%



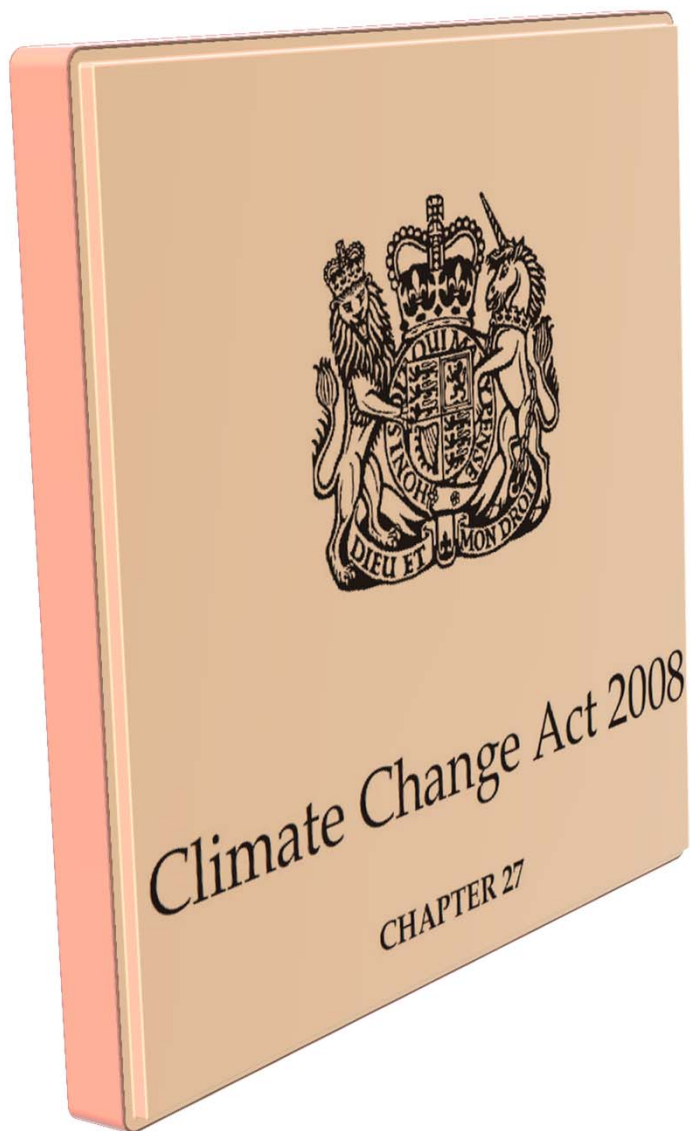

Deforestation/
agriculture/
decay,
36%

Global
GHG
emissions

Buildings,
31%

Energy/
process
emissions

Industry,
35%

Energy/
process CO₂
emissions,
64%

Other,
44%

Industrial
carbon
emissions
10 GtCO₂

Steel,
25%

Cement,
19%

Aluminium,
3%

Plastic,
4%

Paper,
4%



Coal: $650 \text{ W/m}^3/\text{year}$



Oil: $1,430 \text{ W/m}^3/\text{year}$



Gas: $1.3 \text{ W/m}^3/\text{year}$



5,000 Watts per person
 $= 5 \text{ W/m}^2$



Offshore wind: 3 W/m^2



Solar (UK): 5 W/m^2



Biofuel: 0.5 W/m^2

ead_

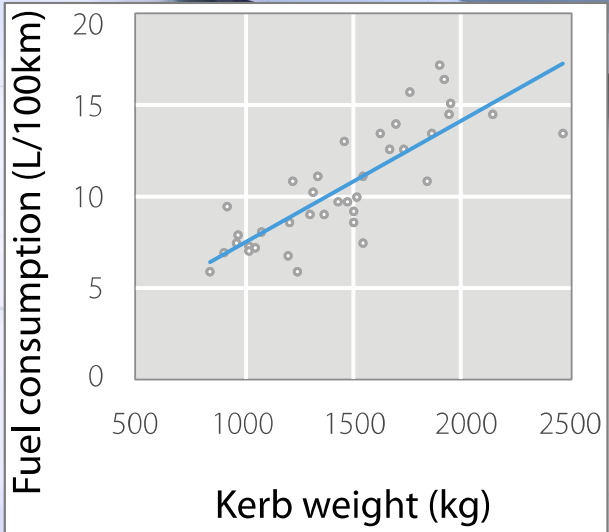





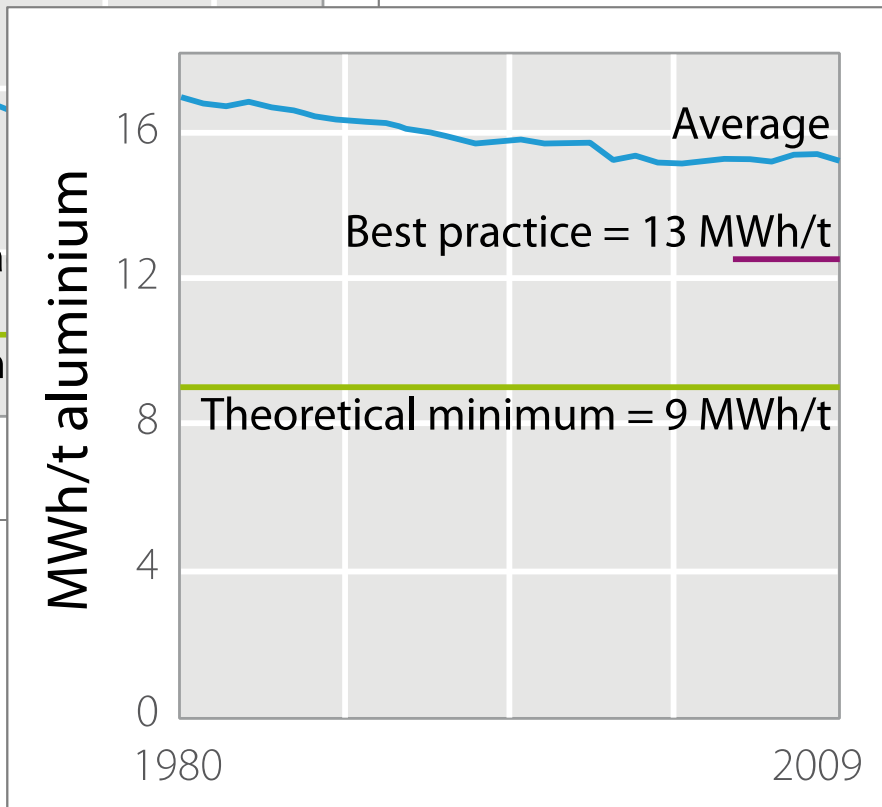
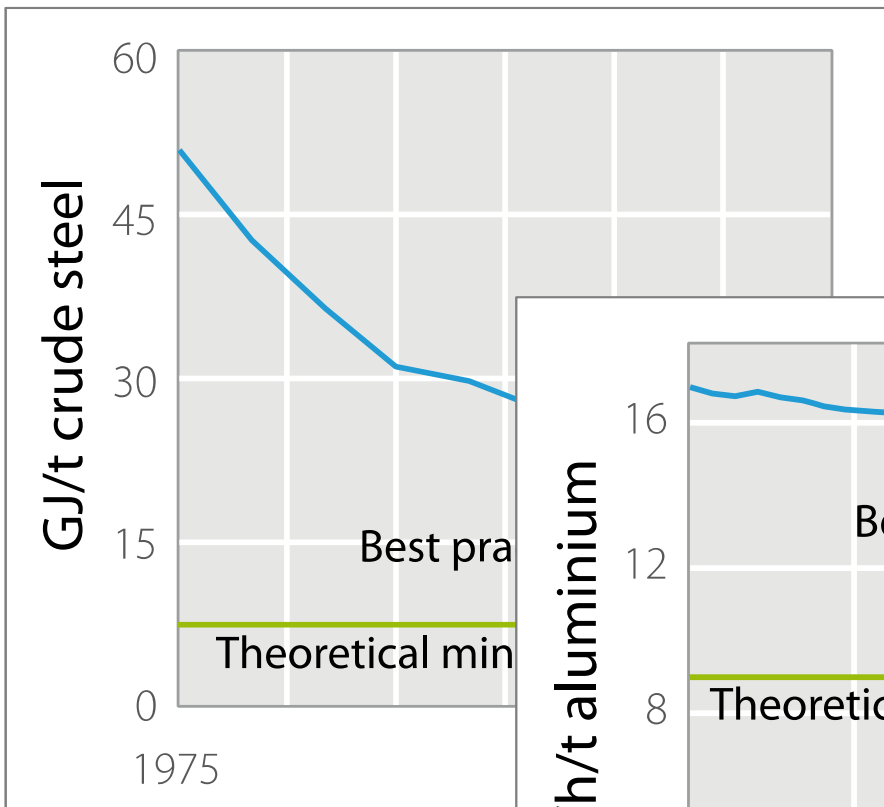

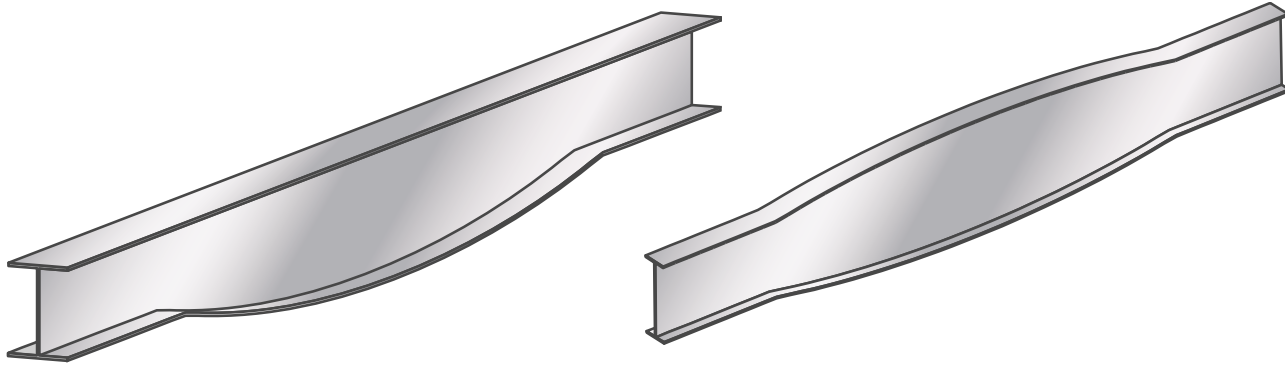

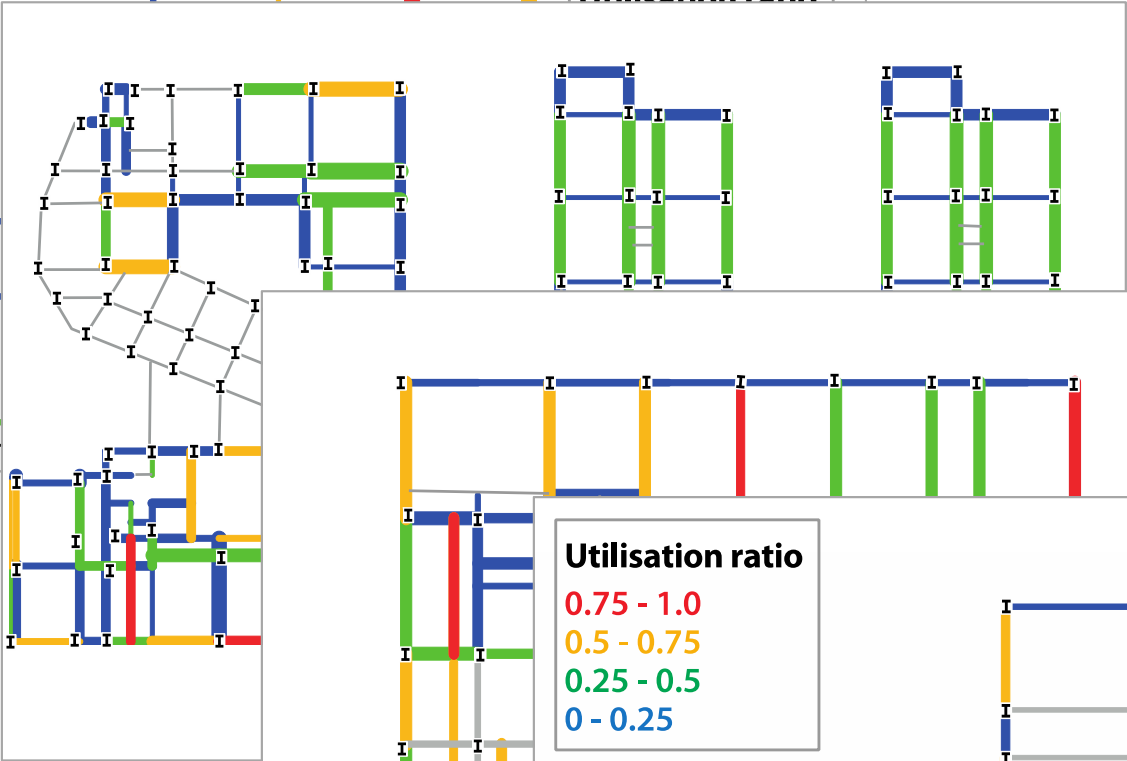
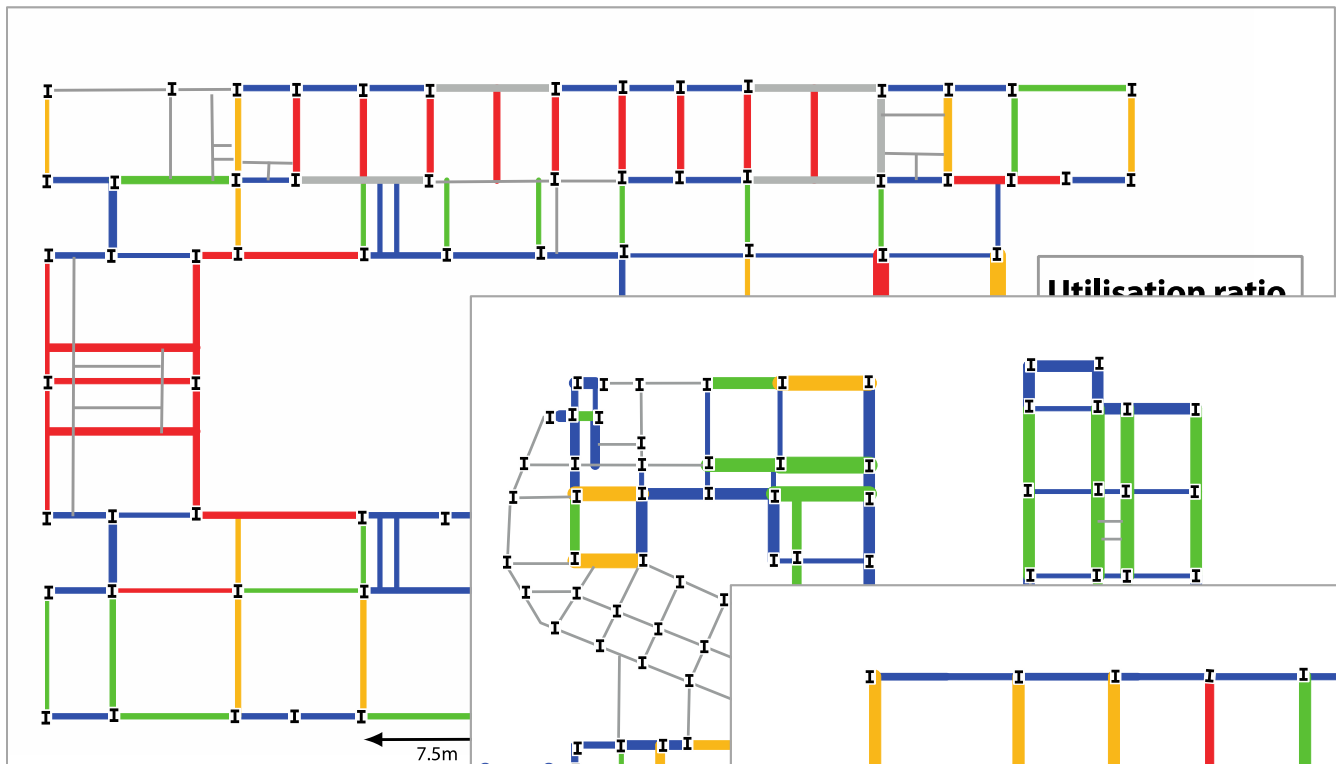

7.5m

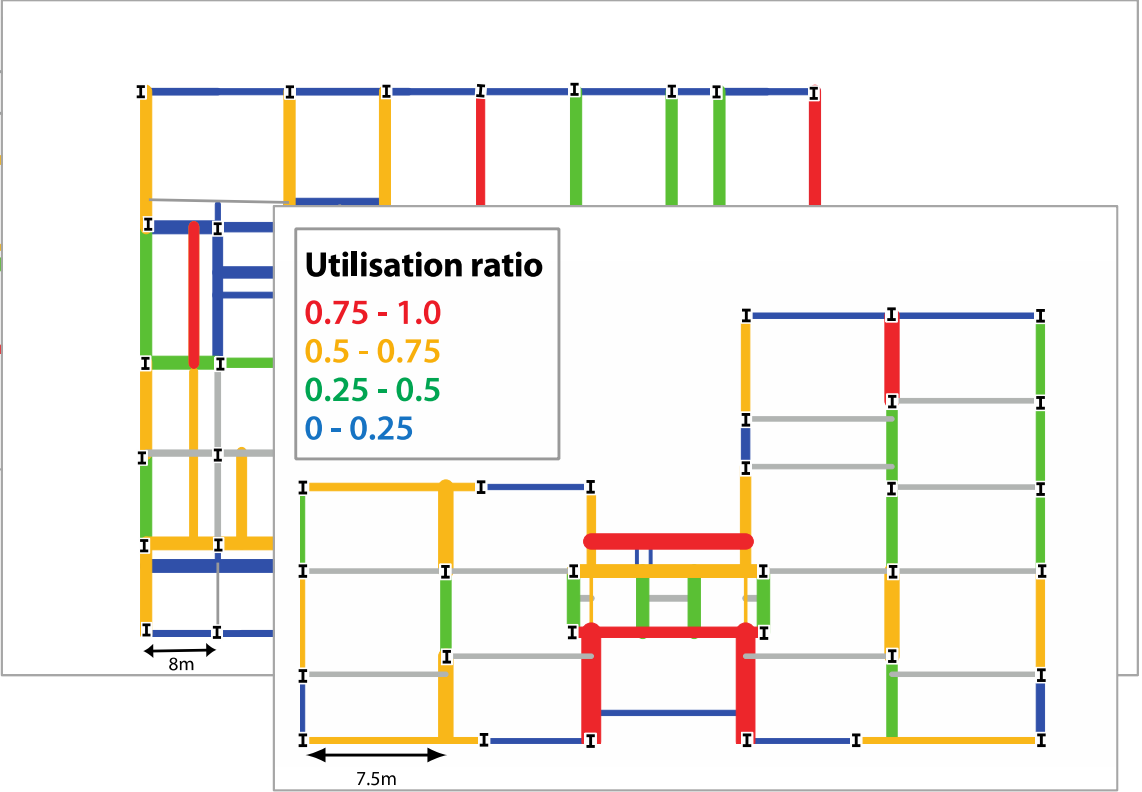

8m

7.5m







Make it lighter

Keep it longer

Use it more

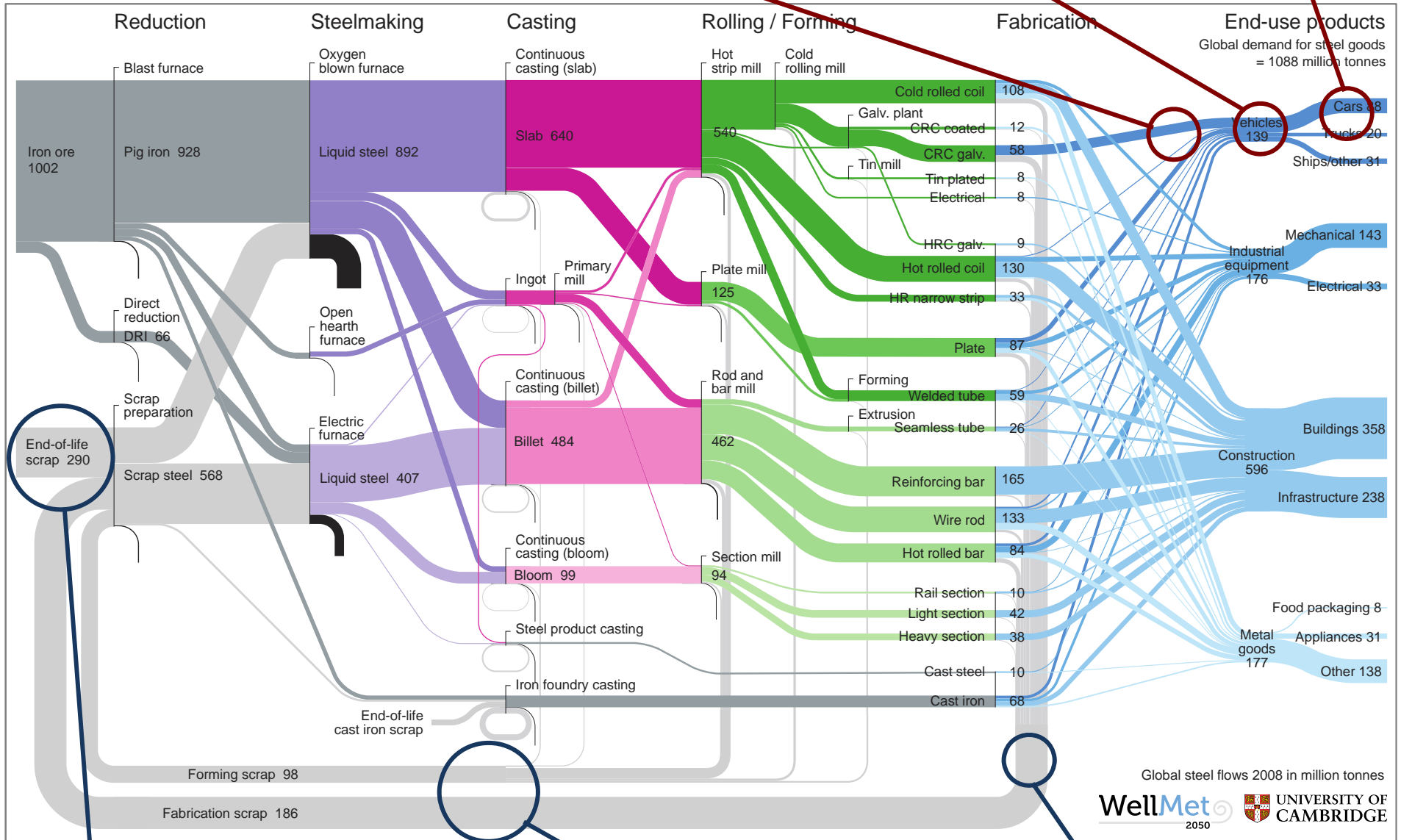

Re-use material

Divert Scrap

Avoid scrap

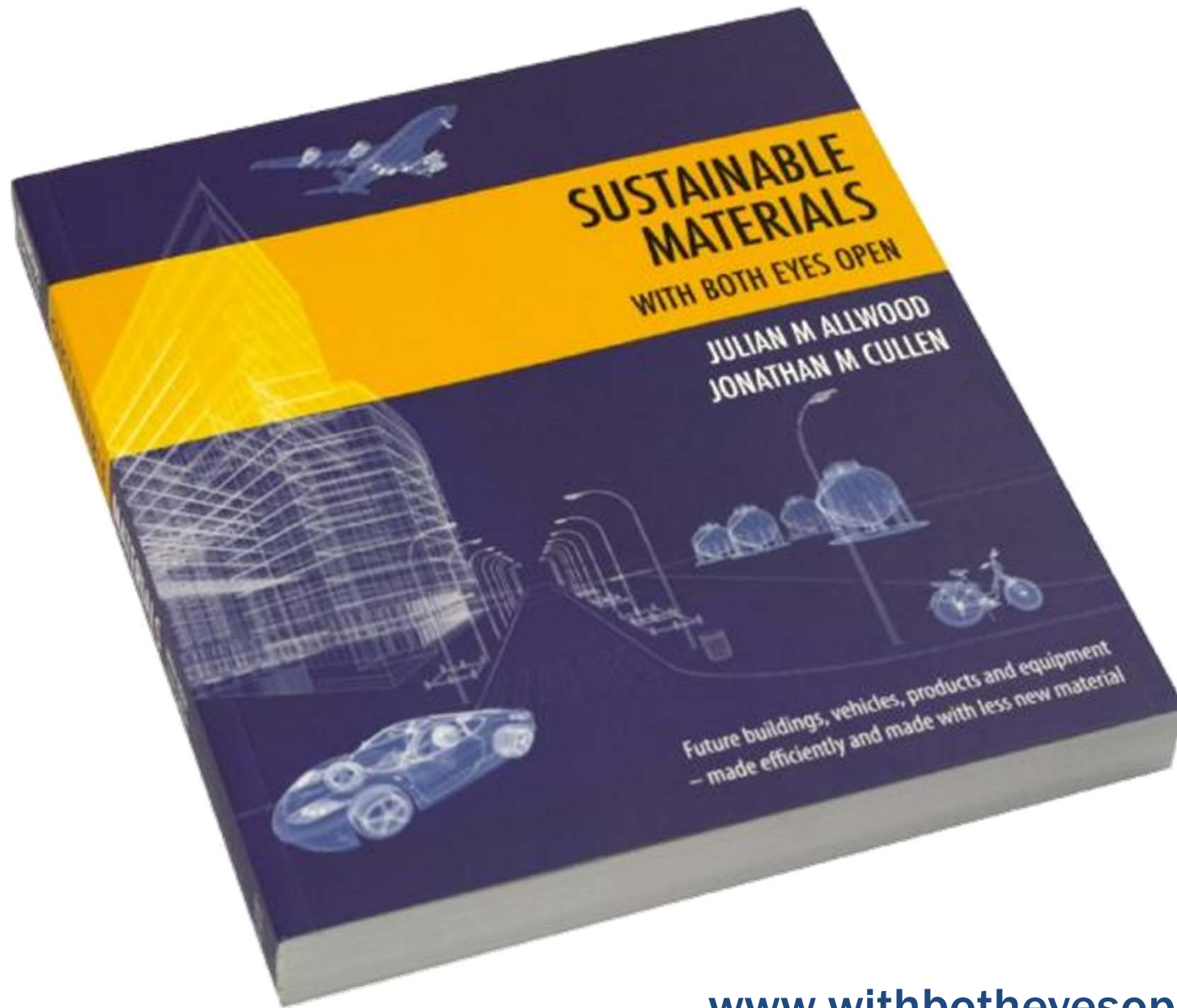

www.withbotheyesopen.com







Johannesburg City Parks Joburg
WELCOME TO DELTA PARK
Thank you for utilizing this park.
The use of facility and playground equipment is at own risk.
Adult supervision required for children under 10 years of age.
The City of Johannesburg Johannesburg City Parks will not
take any responsibility for liability for any injuries
or loss of whatever nature.
PLEASE RESPECT YOUR PARK
TO BOOK THE PARK, PLEASE CALL
011 742 6600

BN 92 HV GP

LWN204 GP

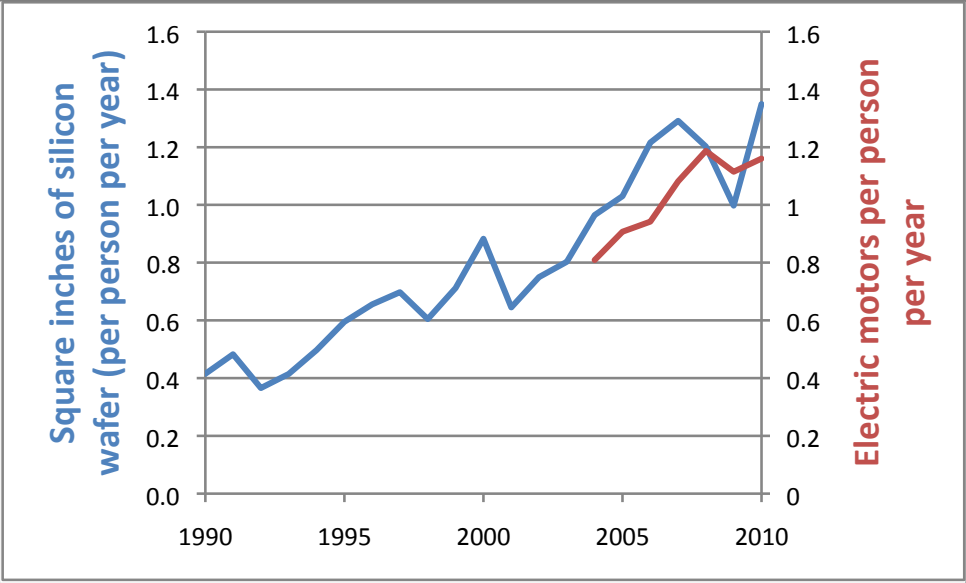
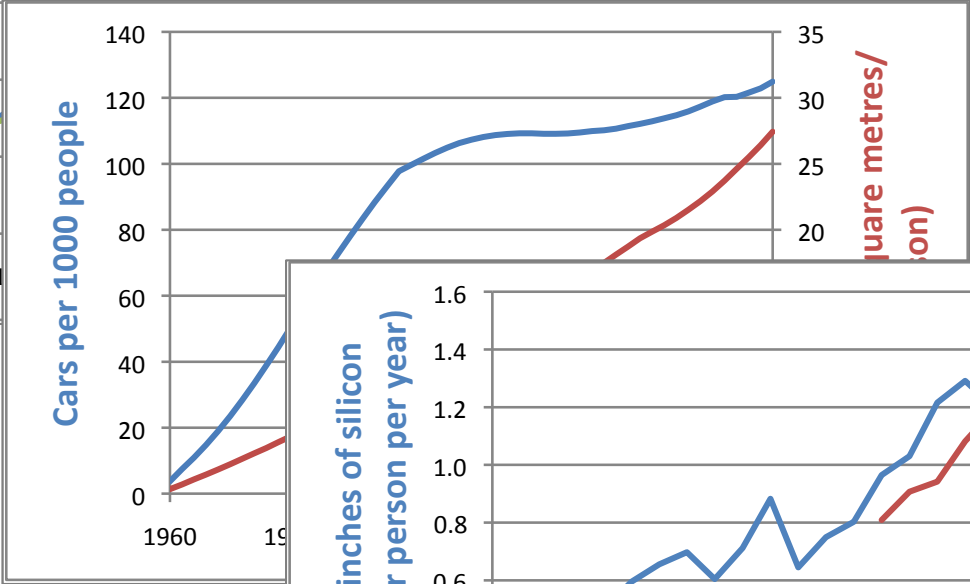
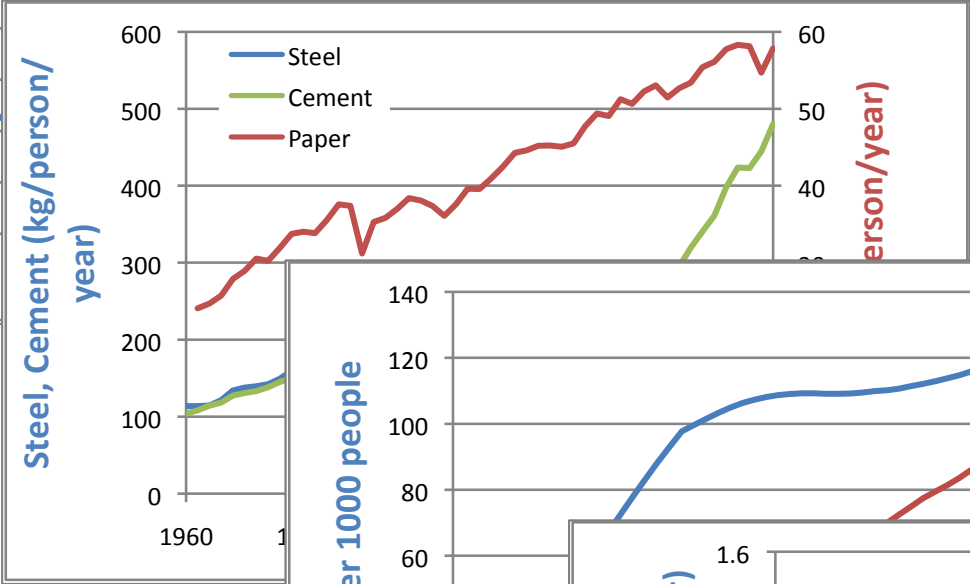
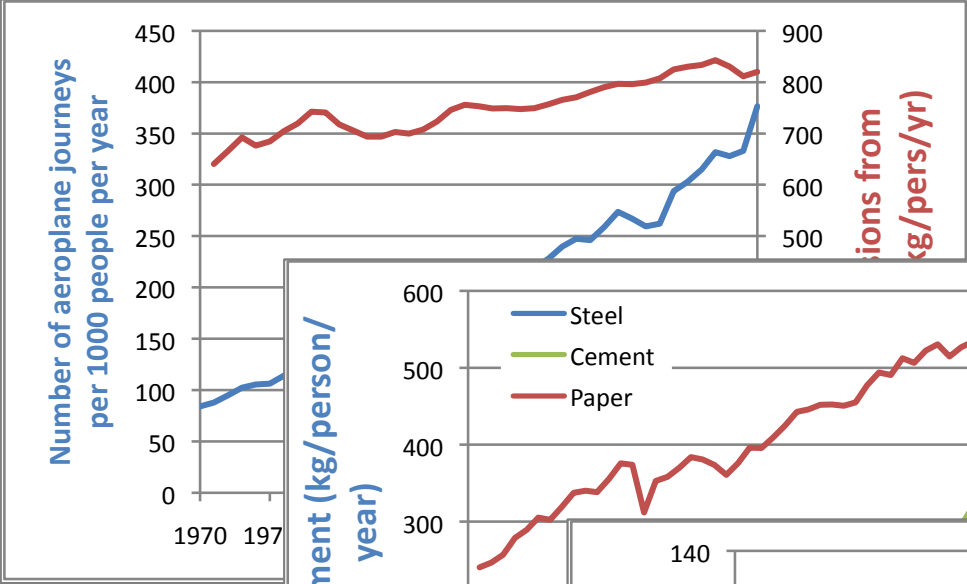







NEAR THIS TABLET
ARE DEPOSITED THE MORTAL REMAINS OF
WILLIAM MEYLER, BOOKSELLER,
A MAGISTRATE,
AND MEMBER OF THE COMMON COUNCIL
OF THE CITY OF BATH;
WHO DIED MARCH 10TH, 1821,
AGED 65 YEARS.

AS A TRADESMAN AND EDITOR OF A
PUBLIC NEWSPAPER.

HE WAS DESERVEDLY ESTEEMED,
FOR INTEGRITY OF CONDUCT AND CONSISTENCY
OF PRINCIPLE;

AS A FATHER AND FRIEND.

HIS MEMORY WILL LONG BE CHERISHED
IN THE HEARTS OF THOSE,
WHO, AS THEY BEST KNEW, CAN BEST APPRECIATE
HIS CLAIMS
TO THEIR LASTING GRATITUDE AND SINCERE
AFFECTION.









"For many ages to come everybody will need to do some work if he is to be contented... we shall endeavour to spread the butter thin on the bread – to make what work there is still to be done to be as widely shared as possible. Three-hour shifts or a fifteen-hour week may put off the problem for a great while.

For the first time since his creation man will be faced with his real, his permanent problem: how to use his freedom from pressing economic cares, how to occupy the leisure, which science and compound interest will have won for him, to live wisely and agreeably and well.

It will be those peoples, who can keep alive, and cultivate into a fuller perfection, the art of life itself and do not sell themselves for the means of life, who will be able to enjoy the abundance when it comes."

John Maynard Keynes
"Economic Possibilities for our Grandchildren" (1931)

The Energy Efficiency
Strategy:
The Energy Efficiency
Opportunity in the UK
Strategy and Annexes



Industrial Energy and Material Demand Reduction

What is UK INDEMAND?



As part of the UK Government's energy efficiency targets, funding has been provided for a [research centre](#) spanning four universities. Please read our introduction to [material efficiency](#).

Watch our videos



Please browse our collection of [videos](#) about our work.

Useful links



Please take a look at our [Useful Links](#) page for other websites which relate to our work.

